

PRODUCT SHEET

Description:

Partition Panel Clamp, Back-To-Back, Alu, Silver Painted, F/4-8 mm Panel Thickness. Incl. 4 Pcs of Bolts M6x25mm & 4 Pcs. of, Plastic Caps

Item number:

22.10.812-0

Units	Box	Carton	HS Code	Barcode
Pcs.	1	100	7616991099	 5704866503327

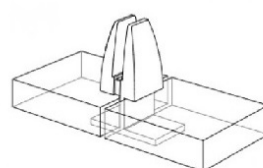
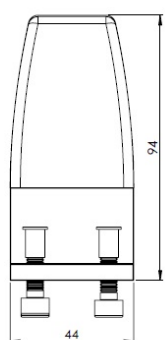
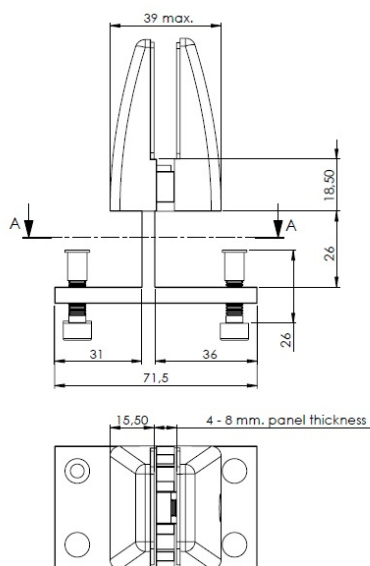

Back-To-Back

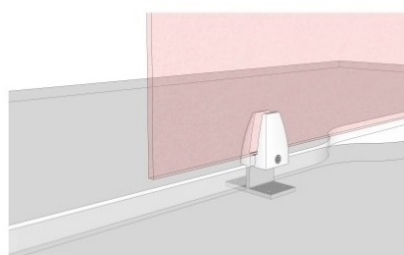
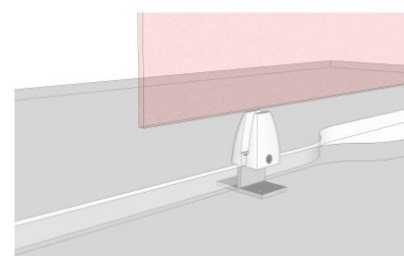
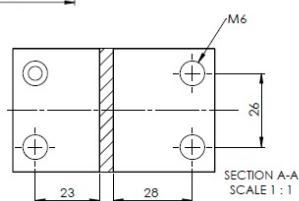

SISO A/S

Mileparken 11
DK-2740 Skovlunde
Denmark
VAT: DK 24786013

Phone +45 45 830 900

www.siso.dk
siso@siso.dk

Danske Bank
Nytorv Branch
Copenhagen
SWIFT: DABADKKK

Account no.
4180 3112 112936
IBAN Account
DK7230003112112936